

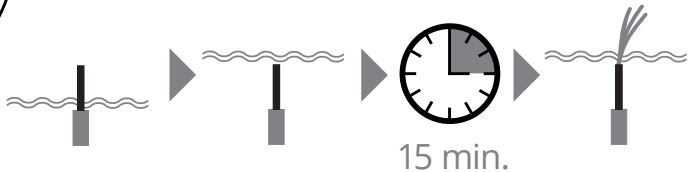

Dry Run Protection
15 m / 50 ft
Item# 19-001560

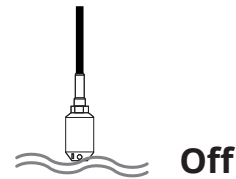
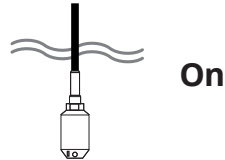
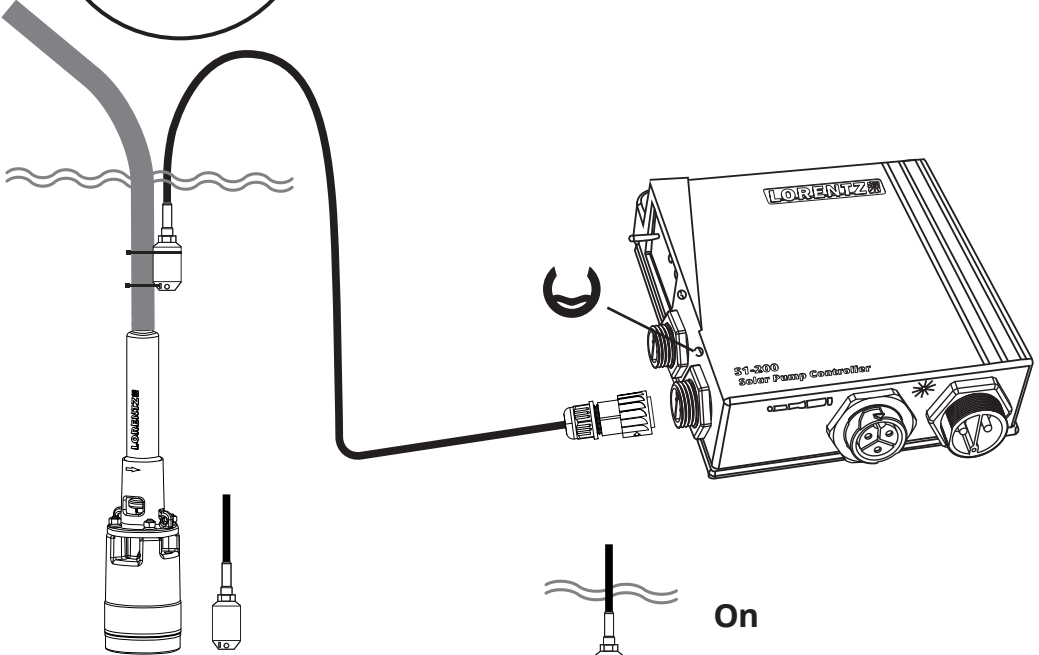

IMPORTANT: You must configure your controller before using your accessories. Use the S-Connect app, see option **A** below. If you do not use the app then manually configure with option **B**.

IMPORTANT : Vous devez configurer votre contrôleur avant d'utiliser vos accessoires. Utilisez l'application S-Connect, voir l'option **A** ci-dessous. Si vous n'utilisez pas l'application, configurez manuellement avec l'option **B**.

IMPORTANTE: Debe configurar su controlador antes de utilizar los accesorios. Utilice la aplicación S-Connect, para ello vea a continuación la opción **A**. Si no utiliza la aplicación, configurelos manualmente con la opción **B**.

A



LORENTZ
S-Connect



1



Settings

2



Advanced
Settings

3



Dry Run
Protection

4



Apply



B

Not applicable after app use.

Non applicable après utilisation de l'application.

Lo siguiente no aplica si ya a usado la aplicación previamente.

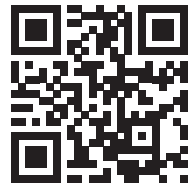

1

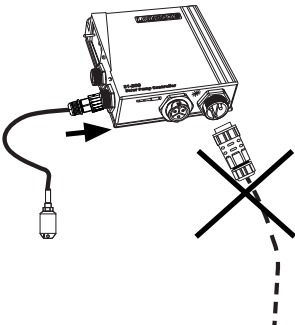

2

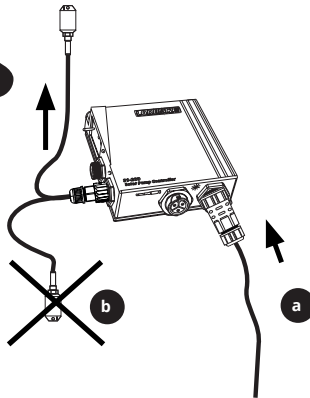

3

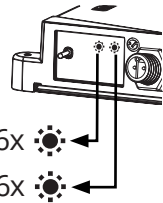

b) detection within 10 seconds

b) détection dans un intervalle de 10 secondes

b) detección en un intervalo de 10 segundos